

C18085_LEILA-Y-W

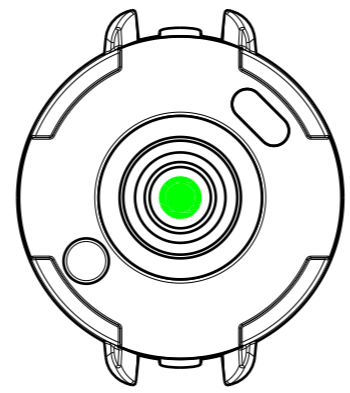

Recommended PAD design

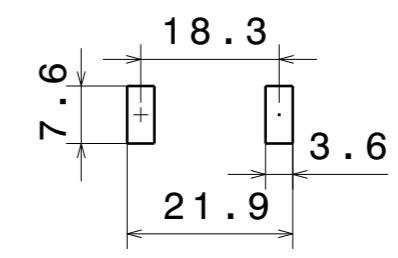

Clip reference distance after soldering

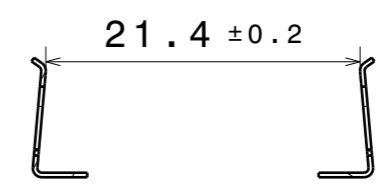

C18696_SOLDER-CLIP-2

Bottom of solder clip underneath holder
Opening of solder clip facing holder

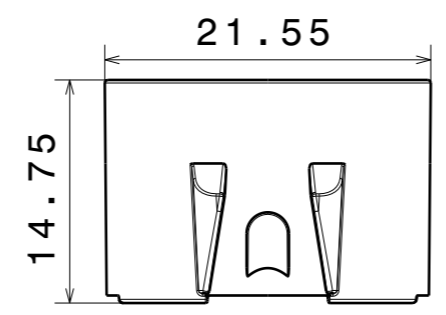
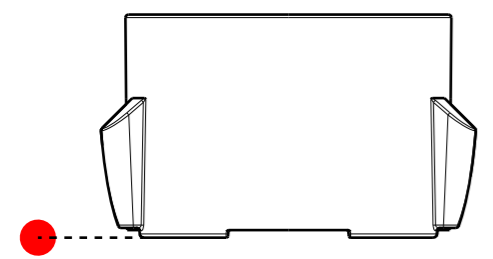
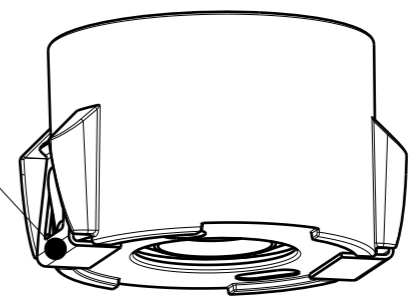

CP19456_LEILA-Y-SC2-W-WHT

COMPONENTS

INDEX	PART	TYPE	COUNT	MATERIAL	COLOR / COATING
1	C18085_LEILA-Y-W	LENS	1	PMMA	CLEAR
2	C19452_LEILA-Y-SC2-HLD-WHT	HOLDER	1	PC	WHITE

MECHANICAL DRAWING

PRODUCT **LEILA-Y-SC2-W**

Plastic moulding general tolerances according to DIN 16901-130 and applies if not otherwise shown in the drawing. Silicone moulding general tolerances according to ISO 3302-1 Class M3 and applies if not otherwise shown in the drawing.

FIRST ANGLE PROJECTION:

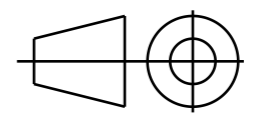

LEDiL

This drawing is the property of LEDiL Oy. It may not be copied or otherwise distributed without prior written permission from LEDiL Oy.

SCALE	2:1	WEIGHT	-	A3	SHEET 1/1
-------	-----	--------	---	----	-----------

Notes

	PCB or heatsink level.
	LED location
	Ensure LED fitting from a product specific 3D model available from www.ledil.com
	For more details about installation please see LEDiL Installation Guide on www.ledil.com