

Recommended PAD design

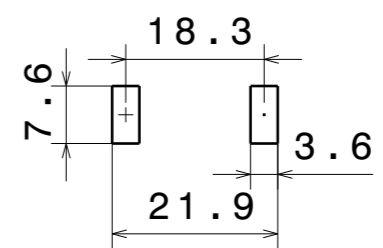

Clip reference distance after soldering

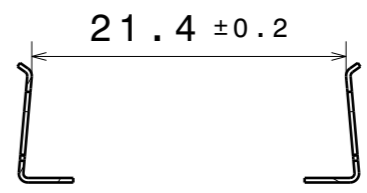

C18696\_SOLDER-CLIP-2  
Bottom of solder clip underneath holder  
Opening of solder clip facing holder

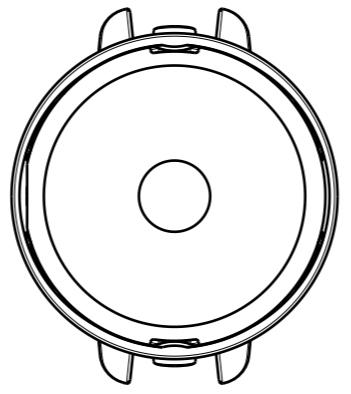
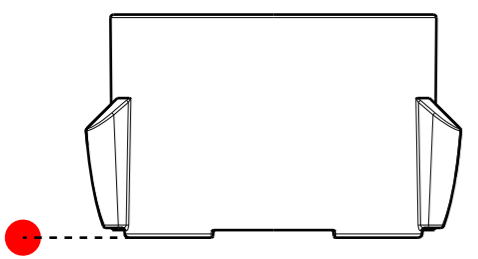
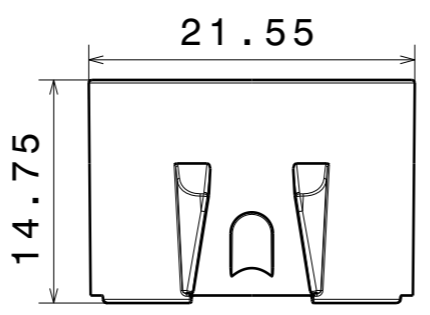
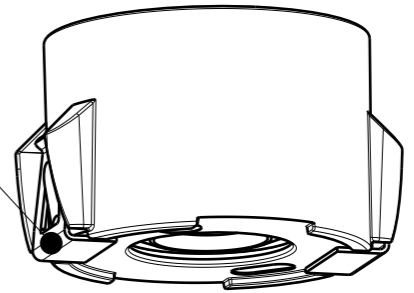

CP19442\_LEILA-Y-SC2-WW

**COMPONENTS**

INDEX	PART	TYPE	COUNT	MATERIAL	COLOR / COATING
1	C18086_LEILA-Y-WW	LENS	1	PMMA	CLEAR
2	C19437_LEILA-Y-SC2-HLD	HOLDER	1	PC	BLACK

**MECHANICAL DRAWING**

PRODUCT **LEILA-Y-SC2-WW**

Plastic moulding general tolerances according to DIN 16901-130 and applies if not otherwise shown in the drawing. Silicone moulding general tolerances according to ISO 3302-1 Class M3 and applies if not otherwise shown in the drawing.

FIRST ANGLE PROJECTION:

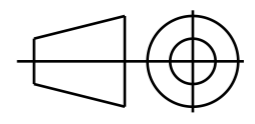

**LEDiL**

This drawing is the property of LEDiL Oy. It may not be copied or otherwise distributed without prior written permission from LEDiL Oy.

SCALE	2:1	WEIGHT	-	A3	SHEET 1/1
-------	-----	--------	---	----	-----------

**Notes**

	PCB or heatsink level.
	LED location
	Ensure LED fitting from a product specific 3D model available from <a href="http://www.ledil.com">www.ledil.com</a>
	For more details about installation please see LEDiL Installation Guide on <a href="http://www.ledil.com">www.ledil.com</a>